

G E R M A N  
P A C K A G I N G  
A W A R D 2 0 1 5

## Two-Color Print and Apply System Hermes C

Made in Germany

# Two-color printing and applying in real-time

Hermes C is the first labeling system worldwide to print and apply two-color labels in one operation. It has been developed and optimized especially for applications corresponding to the new Classification and Labeling Inventory according to GHS.

Due to the integrated backfeed system single labels can be printed and applied on request without loss of labels.

All shapes of packaging can be marked, for example bottles, cans, drums, buckets, cardboard or pallets.

Because of the modular construction system Hermes C offers a proper solution for every application.



- **Designed for industrial application**
- **Simple integration in production lines**
- **Interfaces to connect to ERP and Process Control Systems are available**

When it comes to marking chemicals and hazardous substances, GHS and REACH demand new, standardized pictograms. The guidelines apply worldwide.

As part of this standardization, imperfectly printed danger symbols, for example blank rhombs, are not permitted any longer.

With Hermes C labels can be individually designed and printed.

For your application we provide labels and ribbons, BS5609/3 certified as well (see page 11).

## Sample label

**GLUTARALDEHYDE SOLUTION 50%**

23005 QTY NET 1 KG 0,88 L. BATCH: test281114

**UN 3265**  
CLASS 8 E2

CORROSIVE LIQUID, ACIDIC, ORGANIC,  
N.O.S., Glutaraldehyde  
CAS: 111-30-8

**DANGER** Hazardous Statements Very toxic to aquatic life. May cause respiratory irritation. May cause allergy or asthma symptoms or breathing difficulties if inhaled. May cause an allergic skin reaction. Causes severe skin burns and eye damage. Toxic if swallowed or if inhaled. Harmful to aquatic life with long lasting effects. Precautionary Statements Avoid breathing dust / fume / gas / mist / vapors / spray. Wear protective gloves / protective clothing / eye protection / face protection. In case of inadequate ventilation wear respiratory protection. IF SWALLOWED: immediately call a POISON CENTER or doctor / physician. IF ON SKIN (or hair): remove / take off immediately all contaminated clothing. Rinse skin with water / shower. IF IN EYES: rinse cautiously with water for several minutes. Remove contact lenses, if present and easy to do. Continue rinsing. Immediately call a POISON CENTER or doctor / physician. If experiencing respiratory symptoms: call a POISON CENTER or doctor / physician. Store in a well-ventilated place. Keep container tightly closed. Contains 1,5-pentanedial

cab Produkttechnik GmbH & Co KG · Wilhelm-Schickard-Str. 14 · 76131 Karlsruhe / Germany · Emergency number +49 721 6626-0

All information on scopes of delivery, design and technical specifications correspond to the date of the printing. Subject to change. The data provided in the catalog do not represent any warranty or guarantee. For current data see website [www.cab.de/en/hermes](http://www.cab.de/en/hermes)

# Technical details

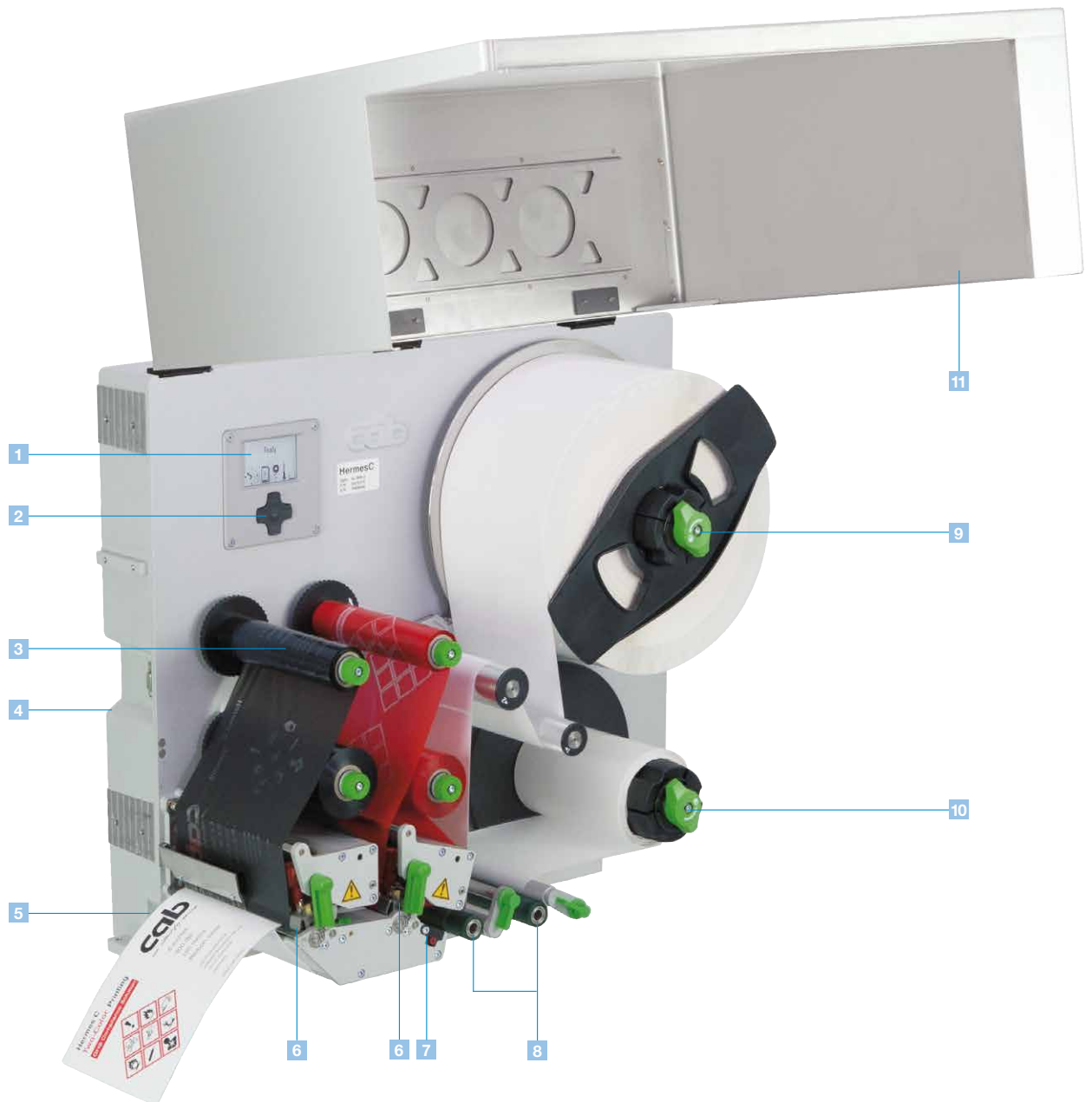

**1 Graphic display**

The white backlight provides good readability. Depending on the installation position, the display may be turned in 90° steps.

**2 Navigator pad**

Simple, interactive menu control, only applicable functions are displayed by the day and night design. Along with the graphic display the menu navigation is easy to understand.

**3 Ribbon holder**

Quick and simple exchange of ribbon due to three-part tightening axles

**4 Metal chassis**

For the mounting of the modules it is made of torsion resistant die-cast aluminum.

**5 Print positioning**

The print position is automatically set after a new label roll has been inserted. The reference value is kept even if the device is switched off.

**6 Print heads 1 and 2**

The pressing force can be adjusted according to the label width.

**7 Ribbon saver**

At print head 1 the print head is lifted within the unprinted area and the ribbon is stopped during label feeding.

**8 Transport system**

Ball bearing mounted rollers provide high printing accuracy.

**9 Label unwinder**

Due to the swing lever and an integrated brake the labels are unwound with constant tension.

**10 Liner rewinder**

The liner of a label roll is completely rewound after the labels have been peeled off. The steering axle enables an easy exchange of the label roll.

**11 Cover**

To protect from dust and damage a cover can be mounted.

# Required interfaces

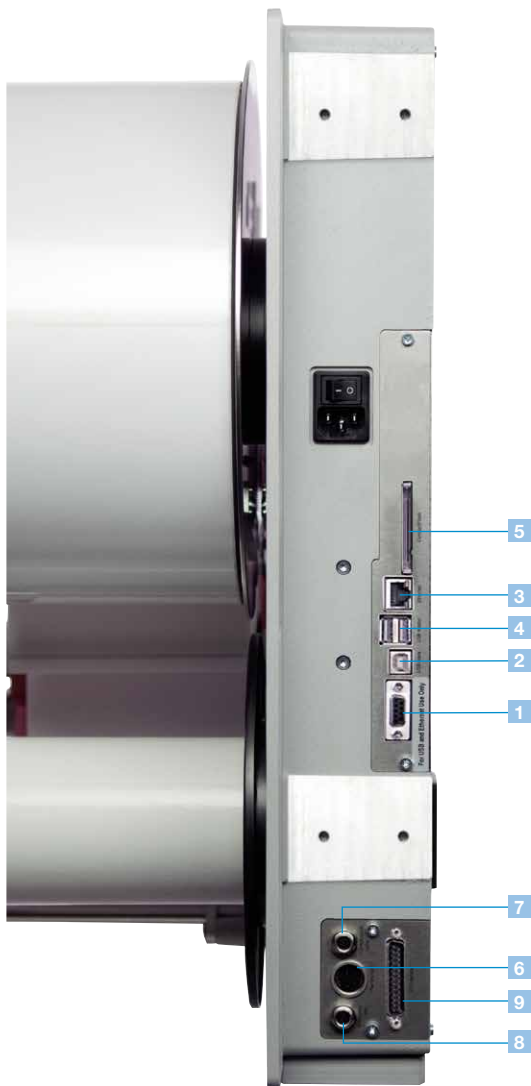

- 1 RS232C interface (restricted function)
- 2 USB 2.0 slave interface
- 3 Ethernet 10/100 Mbit/s interface with TCP/IP
- 4 Two USB master interfaces to connect an external operation panel, a keyboard, a scanner or a service key
- 5 Slot for a CompactFlash Type I memory card
- 6 Connection of a warning light:  
The warning light displays the printer status.  
Green Device switched on  
Yellow Prewarning to end of label resp. ribbon  
Red Error
- 7 Connection of a main valve for air pressure supply:  
For centrally switching on or off the compressed air supply
- 8 Connection of an external E-Stop:  
Along with a connected main valve this interface allows to interrupt compressed air supply in case of emergency.
- 9 Digital I/O interface:  
25-pin Sub-D connector  
Compliant with IEC/EN 61131-2, type 1+3;  
all in- and outputs with galvanic isolation and reverse polarity protection, outputs in addition short circuit protected

## Inputs PNP

- Start printing and applying
- Reprint
- Label feed
- Delete print job
- Pause
- Label dispensed
- Reset
- Stop printing and applying
- Print first label

## Outputs PNP, NPN on request

- Ready to operate
- Print data available
- Paper feed on
- Prewarning end of ribbon
- Prewarning end of label
- Error end of ribbon
- Error end of label
- Label in dispensing position
- Basic position/upper end position
- Applying position/lower end position
- Common alarm

# Technical data

		1.1
<b>Label printer</b>		<b>Hermes C 6L/300-3</b>
<b>Print head</b>		
Method of printing	Thermal transfer	
Printable resolution	dpi	300
Print speed	up to mm/s	125
Print width	up to mm	162.6
<b>Material</b>		
Labels on rolls	Paper, plastics such as PET, PE, PP, PVC, PU, acrylate, PI	
Thickness	mm	0.03-0.06
Width labels <sup>1)</sup>	mm	46-176
liner	mm	50-180
Label height	mm	20-356
Material backfeed	speed	mm/s
	distance	mm
		100 (default setting)
		115
Media roll	outer diameter	up to mm
	core diameter	mm
	winding	Outside or inside
		305
		76
<b>Ribbon</b>		
Ink	Outside or inside	
Roll diameter	up to mm	80
Core diameter	mm	25
Ribbon length	up to m	450
Width <sup>2)</sup>	up to mm	165
Ribbon saver print head 1	■	
<b>Internal rewinder</b>		
Outer diameter	up to mm	210
Core diameter	mm	76
<b>Dimensions and weight</b>		
Height x depth x width	mm	550 x 630 x 320
Weight	approx. kg	30
<b>Label sensor</b>		
Gap sensor	For leading edge of label and end of material	
Distance to locating edge	mm	4-47
<b>Electronics</b>		
Processor 32 bit clock rate	MHz	266
Main storage (RAM)	MB	64
IFFS printer memory	MB Flash	8
Slot for CompactFlash Type I	■	
Battery buffer for real-time clock with printout of time and date/data storage when power off	■	
Warning in case of error	■	
<b>Interfaces</b>		
RS232C 1,200 to 230,400 baud/8 bit	■	
USB 2.0 highspeed slave for PC	■	
Ethernet 10/100 Mbit/s, LPD, RawIP printing, ftp printing, DHCP, HTTP, FTP, SMTP, SNMP, TIME, zeroconf, mDNS, SOAP	■	
2x USB master for external operation panel, keyboard, scanner, service key	■	
Warning light	■	
Digital I/O interface	■	
Connection of applicator	■	
External E-Stop	■	
Main valve for air pressure supply	■	
<b>Operating data</b>		
Power supply	100-240 VAC ~ 50/60 Hz, PFC	
Power consumption	Standby <10 W / typical 100 W / max. 165 W	
Temperature/ operation:	5-40 °C/10-85 % not condensing	
air humidity	stock: 0-60 °C/20-80 % not condensing	
	transport: -25-60 °C/20-80 % not condensing	
Approvals	CE, FCC class A, ICES-3	
<b>Operation panel</b>		
Push buttons/LED	Pause, feed, cancel, menu, enter, 4 x cursor	
LCD graphic display	Width 60 mm, height 40 mm, four lines of text	
<b>Settings</b>		
Time, date, digital or analog clock, language settings, device settings, print parameters, interfaces, security		
<b>On display</b>		
Data reception	Temperature print head	abc debug
Ethernet status	Memory card access	Input buffer
Use memory	Clock/date sheet	Ribbon remaining

■ Standard □ Optionally

<b>Monitoring</b>	
Stop print job	If end of ribbon, end of labels, print head open
Prewarning	If end of ribbon, end of labels
<b>Test routines</b>	
System diagnosis	When switched on, including print head testing
Short status, status print	Fonts list, device list, WLAN status, label profile, test grid, monitor mode, PPP status
Status reports	- Printout on device settings, e.g. print length counter, runtime counter - Request of status via software command - Status messages on display, e.g. network error, no link, barcode error, etc.
<b>Fonts</b>	
Font types	5 bitmap fonts including OCR-A, OCR-B and 3 vector fonts Swiss 721, Swiss 721 bold and monospace 821 internally available, TrueType fonts loadable. Optionally: Chinese (simplified), Thai
Character sets	Windows 1250 to 1257, DOS 437, 737, 775, 850, 852, 857, 862, 864, 866, 869, EBC DIC 500, ISO 8859-1 to -10 and -13 to -16, WinOEM 720, UTF-8, Macintosh Roman, DEC MCS, KOI8-R. All Western and Eastern European, Latin, Cyrillic, Greek, Hebrew and Arabic characters are supported. Optionally: Chinese (simplified), Thai
Bitmap fonts	Size of width and height 1-3 mm, zoom factors 2-10, orientation 0°, 90°, 180°, 270°
TrueType fonts	Size of width and height 0,9-128 mm, variable zoom, orientation 360° in steps of 1°
Font formats	Bold, italic, underlined, outline, inverse, depending on character fonts
Font width	Variable
<b>Graphics</b>	
Graphic elements	Lines, arrows, boxes, circles, ellipses, filled and filled with fading
Graphic formats	PCX, IMG, BMP, TIF, MAC, GIF, PNG
<b>Codes</b>	
1D barcodes (linear)	Code 39, Code 93 Code 39 Full ASCII Code 128 A, B, C EAN 8, 13 EAN/UCC 128 EAN/UPC Appendix 2 EAN/UPC Appendix 5 FIM HIBC Interleaved 2/5 Ident- and lead code of Deutsche Post Codabar JAN 8, 13 MSI Plessey Postnet RSS 14 UPC A, E, E0
2D and stacked codes	Aztec, Codablock F, Data Matrix, PDF 417, Micro PDF 417, UPS Maxicode, QR code, RSS 14 truncated, limited, stacked and stacked omnidirectional, EAN Data Matrix, GS1 Data Bar  All Codes are variable in height, module width and ratio. Orientation 0°, 90°, 180°, 270°. Optionally with check digit, printed characters and start/stop code, depending on type of code
<b>Software</b>	
Programming	JScript direct programming abc Basic Compiler Database Connector ■ ■ ■
Monitoring/administration	Printer monitoring Administration Network Manager ■ ■
Label software	cablabel S3 Lite cablabel S3 Viewer cablabel S3 Pro cablabel S3 Print ■ ■ □ □
Windows printer drivers for	Windows 10 Windows 11 Server 2016 Server 2019 Server 2022 ■  Certification WHQL in preparation
Stand-alone operation	■

<sup>1)</sup> Limitations may apply to small labels, thin materials or strong adhesives. Critical applications need to be tested.

<sup>2)</sup> The ribbon should at least correspond with the carrier material.

# Stroke applicators 4126/4136

2.1



### Tamp pad

Labels are precisely applied on flat surfaces.



### Spring-mounted tamp pad

Allows labels to be applied even on curved surfaces up to approx. 8°.



### Roll-on pad

While in transport, labels are rolled on flat surfaces.

**Silicone form pad on request**

## Stroke applicator

For real-time labeling on packaging or products. According to the type of pad the product is either in motion or not. Labels may be applied on the product from all sides.

The pad is positioned above the peel-off plate. The label is held by the applicator during the printing process. A short stroke cylinder turns the tamp pad horizontally to the labeling position and places the label on the product. The cylinder stroke defines the maximum distance from the peel-off plate to the product.

Stroke applicator		4126C-300	4126C-400	4136C-300 <sup>1)</sup>	4136C-400 <sup>1)</sup>
Cylinder stroke	mm	300	400	300	400
Product height		Variable	Variable	Variable	Variable
Horizontal stroke cylinder	mm	25	25	25	25
Labeling on the product		From top, from below, from the side	From top, from below, from the side	From top, from below, from the side	From top, from below, from the side
Weight of applicator packaging excluded	kg	7	7.5	6.5	7.5
Consumption of power	W max.	15	15	15	15
Air pressure supply	bar	4.5	4.5	4.5	4.5
Blow tube	quantity	1	1	2	2
Cycle time	approx. labels/min. <sup>2)</sup>	20	20	20	20
<b>Tamp pad</b>		<b>4126C-11 F</b>	<b>4126C-12 F</b>	<b>4126C-19 F</b>	–
Label width	mm	46-174			–
Label height	mm	20-100			–
Distance product/lower edge of device up to	mm	220	320	–	–
Immersion depth of pad F <sup>3)</sup> up to	mm	50			–
Product during labeling		Not moving			–
<b>Spring-mounted tamp pad</b>		<b>4126C-3900</b>		<b>4136C-3900</b>	
Label width	mm	80-174		80-174	
Label height <sup>4)</sup>	mm	80-150		151-356	
Distance product/lower edge of device up to	mm	215	315	215	315
Product during labeling		Not moving		Not moving	
<b>Roll-on pad</b>		<b>4126C-4900</b>		<b>4136C-4900</b>	
Label width	mm	50-174		50-174	
Label height <sup>4)</sup>	mm	80-150		151-356	
Distance product/lower edge of device up to	mm	245-275	345-375	275-360	375-460
Product during labeling		In motion		In motion	

<sup>1)</sup> Only in combination with plastic labels    <sup>2)</sup> Calculated at 100 mm label height and 125 mm/s print speed

<sup>3)</sup> If the immersion depth of the applicator is > 25 mm, the cover of Hermes C has to be modified.    <sup>4)</sup> If label height exceeds 210 mm, inside winding is advised.

# Vacuum belt applicators 5326/5426

2.2

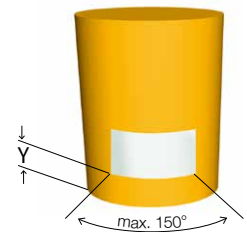
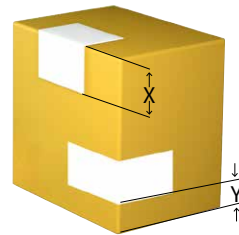
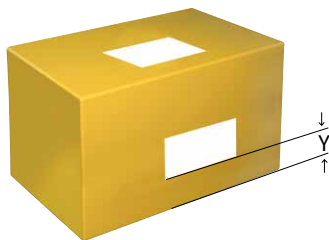

## Vacuum belt applicator

For real-time labeling on packaging or products in motion.

Labels may be applied on the product from all sides on plane or cylindric surfaces, or corner-wrap.

The vacuum belt applicator is positioned in front of the peel-off plate. The printed label is moved to the labeling position via vacuum belt and applied on the packaging via external signal. Printing and labeling may be done simultaneously.









Technical data	Vacuum belt applicator	
	5326C	5426C
Labeling	on plane surfaces	on cylindric surfaces and corner-wrap
Dispensing direction	Left	Left
Label width	mm 46-174	46-174
Label height	mm 80-356	80-356
Product during labeling	in motion	■
Labeling on the product	from top	■
	from below	■
	from the side	■
Product height	Steady	Steady
Product speed	max. m/s 0.5	0.3
Distance between one product and the next min.	m 1.0	0.6
Weight of applicator	packaging excluded kg not specified	9
Consumption of power	W max. 90	90
Stability at application level	F=mm -	10 N x factor 3
Corner wrap labeling	X max. mm -	180
Labeling on a cylinder	diameter min. mm -	Depending on the label length
Vacuum belt speed <sup>1)</sup>	mm/s 100-500	100-300
Cycle time <sup>2)</sup>	max. labels/min. 15	15
Label distance to conveyor belt when labeling from the side	Y min. mm 20	20

<sup>1)</sup> The product speed must be equal or higher than the vacuum conveyor belt speed.

<sup>2)</sup> Calculated at 100 mm label height/print speed 100 mm/s

# Accessories

Extra equipment Hermes C	Product
3.1 	<b>Cover V for vertical mounting</b> The cover protects the Hermes C from dirt and damage.
3.1 	<b>Cover H for horizontal mounting</b> With additional dust protection at the side of the product
3.2 	<b>External operation panel</b> If the operation panel is not accessible after the printer has been installed, an external operation panel may be additionally connected. There is a slot for a CompactFlash Type I memory card and a USB host interface, which is further available.
3.3 	<b>Standard keyboard</b> USB connection, 115 keys
3.4 	<b>Memory card</b> CompactFlash Type I to store label formats, fonts, texts. Graphics are readable and writable either at the printer or the PC.
3.5 	<b>Product sensor 25-pin</b> To be connected at the Hermes C. Start of printing and applying when a product is detected, e.g. on a conveyor belt.
3.6 	<b>Interface connector</b> Screw terminals enable all control signals to be connected at the Hermes C I/O interface.

Interface	Product
4.1 	<b>Label selection – I/O box</b> Via a superordinate control, e.g. PLC, up to 16 different labels can be selected from the memory card.
<b>Connecting cable</b>	
5.1 	<b>Connecting cable RS232C</b> 9/9-pin, length 3 m
Extra equipment Applicators	Product
6.1 	<b>Blow tube 4"</b>
6.1 	<b>Blow tube 6"</b>
6.2 	<b>Air pressure regulation unit</b> To be directly mounted at Hermes C or the bracket with an angle. Presetting at 4,5 bar
6.3 	<b>Air pressure regulation unit with additional main valve</b> In case of integrating the print and apply system in a production line, air pressure for the applicator can be switched on or off externally. Presetting at 4,5 bar. Only in combination with an E-Stop
6.4 	<b>Circular connector</b> 3-pin M8 for main valve for air pressure supply
6.4 	<b>Circular connector</b> 4-pin M8 for E-Stop
6.5 	<b>Pressure relief valve</b> To reduce the tamp force; to be installed in the applicator



# Accessories



## Dispensing and removing labels manually

To dispense and remove labels manually a present sensor is needed. In this case, it is advisable to use a mounting foot. The label printer may be mounted with or without a cover.

### 1 Present sensor PS11

#### 1. Automatic dispensing

The present sensor PS11 detects when the label is in labeling position. After the label has been removed manually the next label is printed instantly.

#### 2. Dispensing on request

The print and apply process can be started by pushing the button at the present sensor

### 2 Hand switch TR2

Printing and dispensing on request via the I/O interface. The hand switch is connected via a cable.



## Mounting foot

To fasten the label printer

### 1 Adapter plate

The label printer is mounted on the adapter plate. It may also be mounted directly at the production line by means of the adapter plate and the profile.

### 2 Profile

Standard length 120 mm; further lengths on request



## Bracket

With the bracket the Hermes C can be mounted on a stand or in a production line in any position.

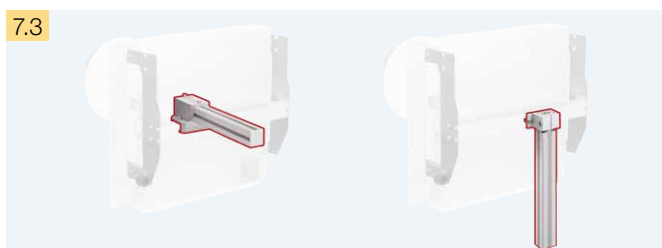

## Clamped joint for profile 50 x 50 mm

With this clamped joint the labeling system can be moved horizontally and vertically.



## Clamped joint for diameter 50 mm

With this clamped joint the labeling system can be moved horizontally and rotated around an axis with a diameter of 50 mm.

# Stands for mounting

7.4

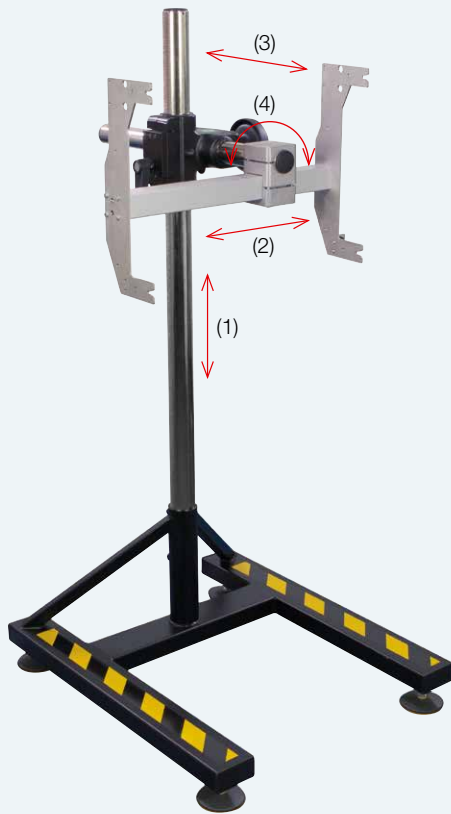

## Stand 1622

For mounting Hermes C in a vertical position into a production line. Height and depth are adjustable by a toothed rack/crank. In addition, the labeling system may be rotated 360° around its axis.

The air pressure regulation unit and the warning light are to be mounted on the bracket.

Technical data		Stand 1622
Adjustable feet	mm	± 15
Load	max. kg	75
(1) Lower edge of printer - ground	mm	150-1,100
(2) Depth crosswise to direction of transport	mm	120
(3) Depth lengthwise to direction of transport	mm	100
(4) Rotation	°	± 90
Weight	approx. kg	40



7.5

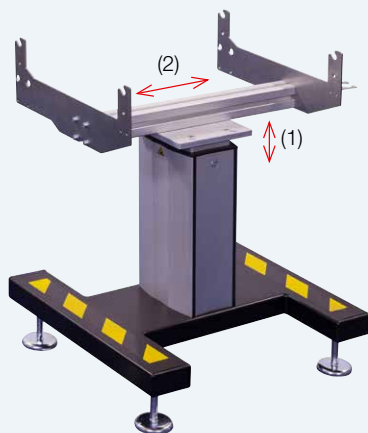

## Stand 1221

For mounting Hermes C in a horizontal position into a production line. Height is adjustable by an internal spindle.

The air pressure regulation unit and the warning light are to be mounted on the bracket.

Technical data		Stand 1221
Adjustable feet	mm	± 15
Load	max. kg	75
(1) Lower edge of label - ground <sup>1)</sup>	mm	720-960
(2) Depth lengthwise to direction of transport	mm	± 180
Weight	approx. kg	40

<sup>1)</sup> Further dimensions on request

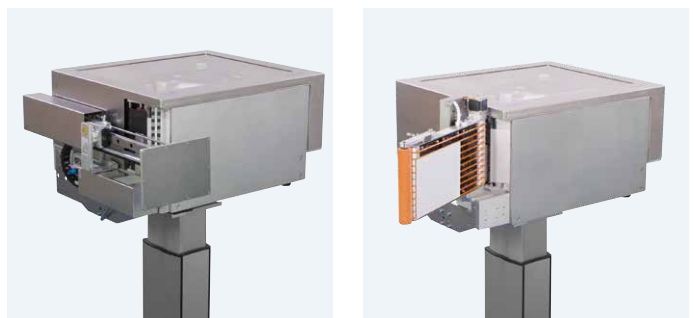

# Labels and ribbons

- **Two-color** printing on labels in real-time
- For chemical products such as oils, colors or detergents
- On drums, buckets, boxes, pallets etc., resistant to acid and saltwater
- Labels for two-color printing according to GHS
- Certified according to British Maritime Standard BS5609, part 3

In this test, labels that have spent at least three months in sea water must stay affixed on aluminum drums and printed data must still be legible.

For this purpose, cab provides labels made of polyester or polypropylene as well as proper ribbons. Please contact cab.

## Sample label



### GLUTARALDEHYDE SOLUTION 50%

23005 QTY NET 1 KG 0,88 L. BATCH: test281114

**UN 3265**  
CORROSIVE LIQUID, ACIDIC, ORGANIC,  
CLASS 8 E2 N.O.S., Glutaraldehyde  
CAS: 111-30-8

**DANGER** Hazardous Statements Very toxic to aquatic life. May cause respiratory irritation. May cause allergy or asthma symptoms or breathing difficulties if inhaled. May cause an allergic skin reaction. Causes severe skin burns and eye damage. Toxic if swallowed or if inhaled. Harmful to aquatic life with long lasting effects. Precautionary Statements Avoid breathing dust / fume / gas / mist / vapors / spray. Wear protective gloves / protective clothing / eye protection / face protection. In case of inadequate ventilation wear respiratory protection. IF SWALLOWED: immediately call a POISON CENTER or doctor / physician. IF ON SKIN (or hair): remove / take off immediately all contaminated clothing. Rinse skin with water / shower. IF IN EYES: rinse cautiously with water for several minutes. Remove contact lenses, if present and easy to do. Continue rinsing. Immediately call a POISON CENTER or doctor / physician. If experiencing respiratory symptoms: call a POISON CENTER or doctor / physician. Store in a well-ventilated place. Keep container tightly closed. Contains 1,5-pentanedial

cab Produkttechnik GmbH & Co KG · Wilhelm-Schickard-Str. 14 · 76131 Karlsruhe / Germany · Emergency number +49 721 6626-0



### Labels

Labels of all sizes, with widths 46 to 176 mm and heights 20 to 356 mm, can be manufactured for Hermes C.



### Ribbons

They are harmonized with Hermes C and the label materials and offer an excellent print quality from the beginning of the roll to the end.

The resin ribbons withstand dissolvers and heat and are highly resistant to abrasion and scratching.

# Software features of the label printer

J	<b>Job start</b>
H 100	<b>Speed (100 mm/s)</b>
O R	<b>Orientation rotated by 180°</b>
S I1;0,0,68,70,100	<b>Size label (100x68 mm, gap 2 mm)</b>
T 10, 10,0,5,pt20;sample	<b>Text object/font: Swiss bold, 20 pt</b>
B 10,20,0,EAN-13,SC2,401234512345	<b>Barcode EAN 13, size SC 2</b>
G 8,3,5,0;R:30,9,0,3;0,3	<b>Graphic, box 30x9 mm,</b>
A 1	<b>Line weight 0.3 mm</b>
	<b>Number of labels (in this example 1)</b>

## Direct programming with JScript

Every cab printer can be directly programmed with the JScript programming language. JScript is described in the programming manual. The label software cablabel S3 optimally supports the direct programming, but may also be generated with any text editor.

## SAP® Member Silver Printer Vendor Program

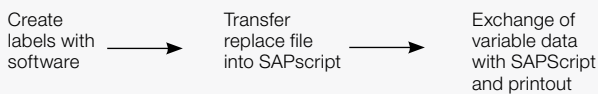

## Replace files and integration in SAP R/3\*)

In cooperation with SAP cab developed the so-called replace method to control cab printers quickly and easily from SAPscript using SAP R/3. Using this method the host computer only sends the JScript variable, respectively changed data to the printer. As a Silver Level partner in SAP's Printer Vendor Program, cab has access to SAP development environments for optimum printer support.

```

<ABC>
label start
input a$
if left$(a$,15)="194300301480070" then
  print "R t2;";mid$(a$,16)
endif
if left$(a$,15)="194300300580172" then
  print "R t3;";mid$(a$,16)
endif
if left$(a$,15)="194300301970073" then
  print "R t1;";mid$(a$,16)
endif
if a$0"Q0001" then
  print "A 1"
endif
goto start
  
```

## abc Basic Compiler

As an integrated element of the firmware, the abc Basic Compiler enables the printer to process data via Basic programming before it is sent for print editing. That way, you replace external printer languages or integrate data from other systems, e.g. a scale or PLC.

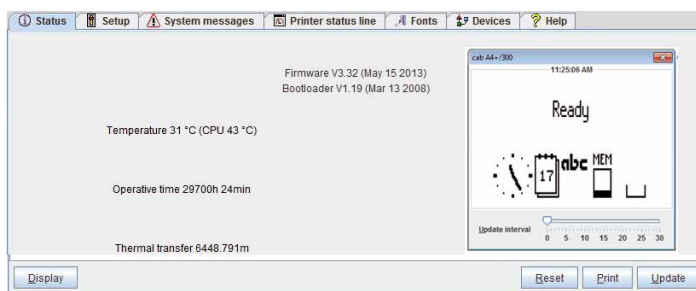

## Printer monitoring with Intra- and Internet

Using standard programs such as the web browser or ftp clients, the integrated HTTP and ftp servers enable printer monitoring and configuration, firmware updates and memory card administration. Status, warning and error messages are sent to administrators or users via e-mails or SNMP datagrams via SNMP and SMTP clients. A time server is used to synchronize time and date.

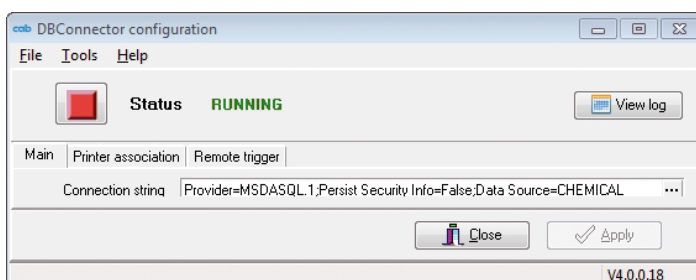

## Database Connector

In stand-alone operation with additional network connection this program allows the printer to access data directly from a central ODBC or OLEDB compatible database and print it on a label. At the same time, data can be written back to the database during the printing process. Integrating the Database Connector in cablabel S3 allows to conveniently establish this database connection when designing a layout.

\*) SAP and all SAP logos are trademarks or registered trademarks of SAP SE in Germany and in several other countries.

## Software tools – label software

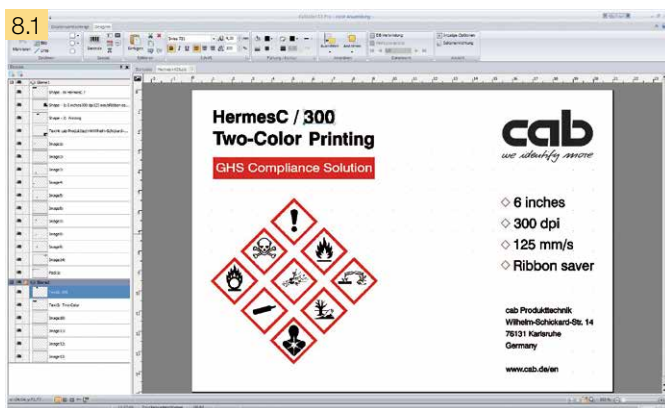

cablabel S3 is available for Microsoft\*) operating systems.

Terminal servers/Citrix are not supported.

cablabel S3 is a label software that supports two-color applications. Three functions are integrated:

- **Designing**
- **Printing**
- **Monitoring**

cablabel S3 does open up the full potential of cab devices in the design of your label. An extensive instruction set is available within the intuitive user interface, e.g. different date formats, mathematic or logic functions.

In doing so, cablabel S3 brings together all cab marking systems. First of all you design the label. You do not have to decide before printing whether you like the label to be dispensed on a label printer, a print and apply system or a laser marking system.

Do you like your marking system to print independently of a host system in stand-alone operation? cablabel S3 supports again: After having designed the label, the software supplies with all necessary data stored within the printer to be used in stand-alone operation.

cablabel S3 is of modular design and can be adapted to your requirements step by step: In order to support functions like native programming with JScript, elements like JScript viewer are embedded as plugin. The designer user interface and JScript code are synchronized in real-time. Special functions like Database Connector or barcode testers can be easily integrated.

## Software tools – monitoring

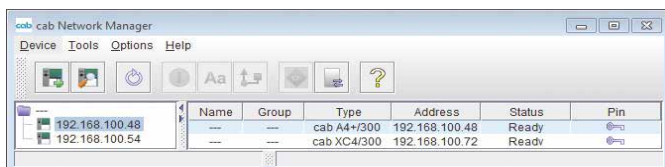

### Administration Network Manager

To simultaneously control a number of printers across a network. It supports monitoring, configuration, firmware updates, memory card administration, file synchronization and PIN administration from one place.

## Printer drivers

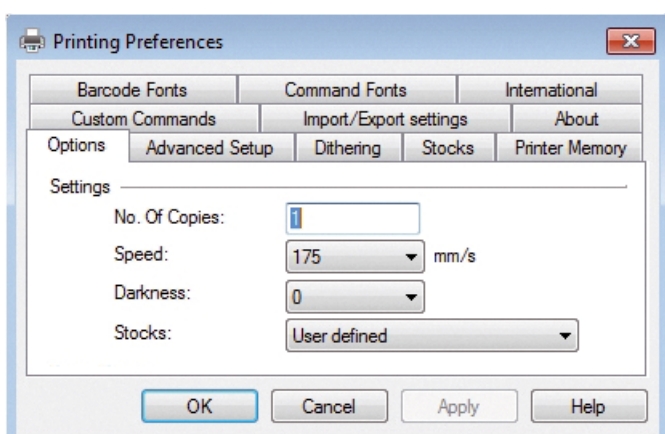

### Windows printer drivers for



















Windows 10  
Windows 11  
Windows Server 2016  
Windows Server 2019  
Windows Server 2022

Certification WHQL in preparation

















Free download on [www.cab.de/en/support](http://www.cab.de/en/support)

\*) Microsoft is a registered trademark of the Microsoft Corporation.

# Product range

1.1		<b>Part no.</b> <b>5970313</b>	<b>Device</b> Label printer Hermes C 6L/300-3
		<b>Part no.</b>	<b>Applicators</b>
2.1		<b>5972120</b> <b>5972125</b> <b>5972290</b> <b>5972295</b>	Stroke applicator 4126C-300 Stroke applicator 4126C-400 Stroke applicator 4136C-300 Stroke applicator 4136C-400
		<b>xxxxxxx*)</b>	Tamp pad 4126C-11 F WxH Tamp pad 4126C-12 F WxH Tamp pad 4126C-19 F WxH
		<b>xxxxxxx*)</b>	Spring-mounted tamp pad 4126C-3900 WxH
		<b>xxxxxxx*)</b>	Spring-mounted tamp pad 4136C-3900 WxH
		<b>xxxxxxx*)</b>	Roll-on pad 4126C-4900 WxH
2.2		<b>5972910</b> <b>5972140</b>	Vacuum belt applicator 5326C Vacuum belt applicator 5426C
			<b>Part no.</b> <b>Hermes C extra equipment</b>
3.1		<b>5970475.001</b>	Cover V for vertical mounting
		<b>5972493.001</b>	Cover H for horizontal mounting including dust protection
3.2		<b>5954380</b>	External operation panel
3.3		<b>5901626</b>	Standard keyboard USB de
3.4		<b>5561043</b>	CompactFlash Type I memory card
3.5		<b>5964300</b>	Product sensor 25-pin Connection Hermes C
3.6		<b>5917651</b>	I/O interface connector Sub-D plug 25-pin Phoenix Contact No. 2761622
3.8		<b>5972287</b>	Present sensor PS11
3.9		<b>5955710</b>	Hand switch TR2
		<b>Part no.</b>	<b>Interfaces</b>
4.1		<b>5948205</b>	Label selection - I/O box
		<b>Part no.</b>	<b>Connecting cable</b>
5.1		<b>5550818</b>	Connecting cable RS232C 9/9-pin, length 3 m

\*) User specific part no. following request

		<b>Part no.</b>	<b>Applicators extra equipment</b>
6.1		<b>5964095.001</b>	Blow tube 4"
		<b>5964614.001</b>	Blow tube 6"
6.2		<b>5955735</b>	Air pressure regulation unit L
6.3		<b>5955737</b>	Air pressure regulation unit L with additional main valve
6.4		<b>5918092</b>	Circular connector 3-pin M8
		<b>5918003</b>	Circular connector 4-pin M8
6.5		<b>5972xxx.212</b>	Pressure relief valve
		<b>Part no.</b>	<b>Mounting aids</b>
7.1		<b>5972289</b>	Mounting foot 120
		<b>xxxxxxx*)</b>	Mounting foot XXX, height customized
		<b>5972282</b>	Adapter plate
		<b>xxxxxxx*)</b>	Profile XXX, length customized
7.2		<b>5972291</b>	Bracket C
7.3		<b>8914443</b>	Clamped joint for profile 50 x 50 mm
		<b>5907394</b>	Clamped joint for diameter 50 mm
7.4		<b>5972230</b>	Stand 1622
7.5		<b>5972447</b>	Stand 1221
		<b>Part no.</b>	<b>Software</b>
8.1		Bundle	Label software cablabel S3 Lite (Download at cab.de/en)
		<b>5588001</b>	cablabel S3 Pro 1 WS
		<b>5588100</b>	cablabel S3 Pro 5 WS
		<b>5588101</b>	cablabel S3 Pro 10 WS
		<b>5588150</b>	cablabel S3 Pro 1 addit. licence
		<b>5588151</b>	cablabel S3 Pro 4 addit. licence
		<b>5588152</b>	cablabel S3 Pro 9 addit. licence
		<b>5588002</b>	cablabel S3 Print 1 WS
		<b>5588105</b>	cablabel S3 Print 5 WS
		<b>5588106</b>	cablabel S3 Print 10 WS
<b>5588155</b>	cablabel S3 Print 1 addit. licence		
<b>5588156</b>	cablabel S3 Print 4 addit. licence		
<b>5588157</b>	cablabel S3 Print 9 addit. licence		
8.2		<b>9008486</b>	Programming manual en, printed copy

# Overview of cab products

Label printers  
**MACH1, MACH2**



Label printers  
**EOS 2**



Label printers  
**EOS 5**



Label printers  
**MACH 4S**



Label printers  
**SQUIX 2**



Label printers  
**SQUIX 4**



Label printers  
**SQUIX 6.3**



Label printers  
**SQUIX 8.3**



Label printers  
**XD Q double-sided**



Label printers  
**XC Q two-colored**



Print and apply systems  
**HERMES Q**



Print and apply systems  
**Hermes C two-colored**

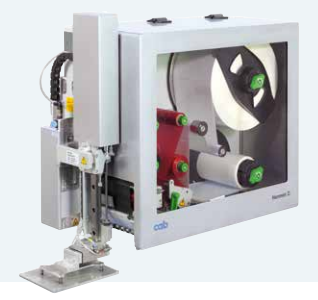

Tube labeling systems  
**AXON 1**



Print modules  
**PX Q**



Labels and ribbons



Label software  
**cablabel S3**



Label dispensers  
**HS, VS**



Labeling heads  
**IXOR**



Marking lasers  
**XENO 4**



Laser marking systems



 Headquarters and fabrication in Germany

 to  International subsidiaries

There are further 820 distribution and service partners in more than 80 countries.



## Europe

### Germany

cab Produkttechnik GmbH & Co KG  
Wilhelm-Schickard-Str. 14  
76131 Karlsruhe  
phone +49 721 6626 0  
fax +49 721 6626 129  
[info@cab.de](mailto:info@cab.de)  
[www.cab.de](http://www.cab.de)

### France

cab Technologies S.à.r.l.  
2a Rue de la Moder  
Z.A. Nord du Val de Moder  
67350 Niedermodern  
phone +33 388 722501  
fax +33 388 722502  
[info.fr@cab.de](mailto:info.fr@cab.de)  
[www.cab.de/fr](http://www.cab.de/fr)

## America

### USA

cab Technology, Inc.  
21 Alpha Road, Suite 200  
Chelmsford, MA 01824  
phone +1 978 250 8321  
fax +1 978 256 9564  
[info.us@cab.de](mailto:info.us@cab.de)  
[www.cab.de/us](http://www.cab.de/us)

### Latin America

Alejandro Balmaceda  
Hacienda Jurica Pte 1615  
Colonial de Valle  
32553 Juárez, Mexico  
phone +52 656 682 4301  
[a.balmaceda@cab.de](mailto:a.balmaceda@cab.de)  
[www.cab.de/es](http://www.cab.de/es)

## Asia

### Taiwan

cab Technology Co., Ltd.  
16F-1, No. 700, Jhong Jheng Rd  
Junghe, Taipei 23552  
phone +886 (02) 8227 3966  
fax +886 (02) 8227 3566  
[info.asia@cab.de](mailto:info.asia@cab.de)  
[www.cab.de/tw](http://www.cab.de/tw)

### China

cab (Shanghai) Trading Co., Ltd.  
Room 908, Building D  
No. 999, Jin Zhong Rd  
Shanghai 200335  
phone +86 (021) 6236 3161  
fax +86 (021) 6236 3162  
[info.cn@cab.de](mailto:info.cn@cab.de)  
[www.cab.de/cn](http://www.cab.de/cn)

### Singapore

cab Singapore Pte. Ltd.  
59 Ubi Avenue 1 #04-05  
Singapore 408938  
phone +65 6931 9099  
[info.asia@cab.de](mailto:info.asia@cab.de)  
[www.cab.de/en](http://www.cab.de/en)

## Africa

### South Africa

cab Technology (Pty) Ltd.  
8 Fabriek Street  
Strijdom Park  
Randburg 2169  
phone +27 11 886 3580  
fax +27 11 789 3913  
[info.za@cab.de](mailto:info.za@cab.de)  
[www.cab.de/za](http://www.cab.de/za)